

## A good preparation!

Keep the following attention points into account when ordering an awning.

### 1. Determine the desired width.

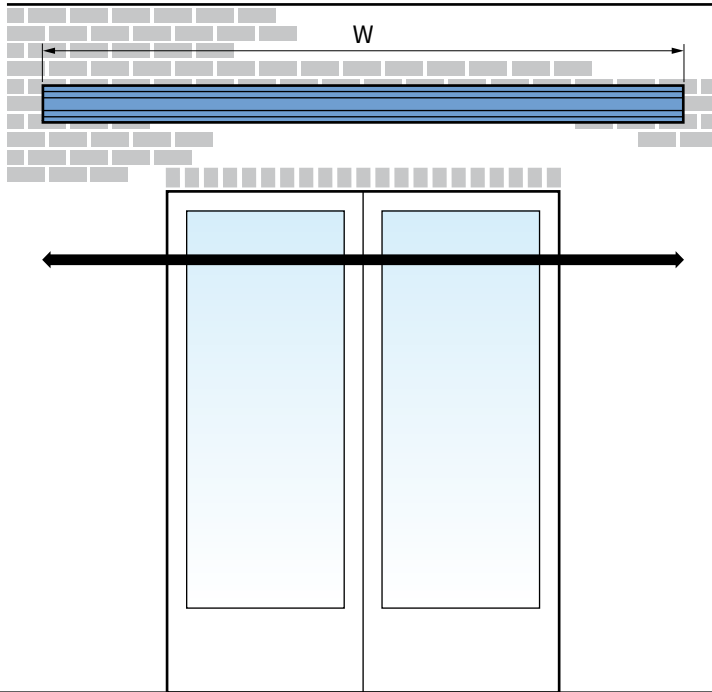

An awning ensures that sunlight will not enter the house, but also provides a shady terrace in your garden. It is therefore advisable to measure the awning as wide as possible, but always stay 20 cm inside the outer corners.

Width (W) = \_\_\_\_\_ mm

### 2. Choose the desired projection.

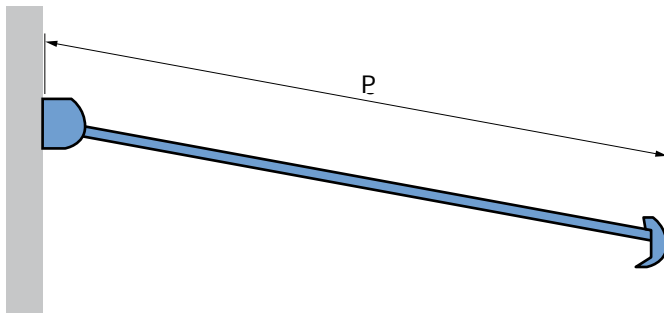

Projection is the maximum distance between the wall and the front bar. The bigger the projection, the bigger the effect of the sun awning. For more information, please see the specifications on page 3.

Projection (P) = \_\_\_\_\_ mm

### 3. Choose the control side.

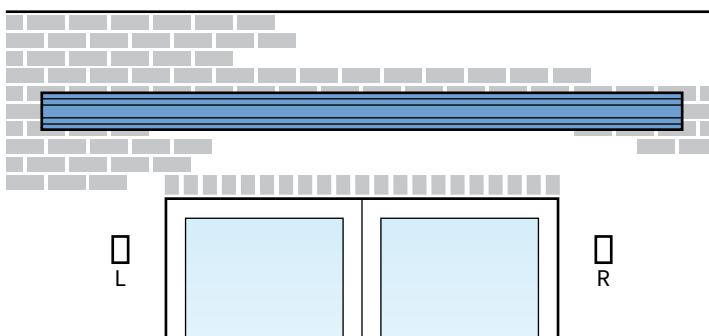

Determine the control side. The control side is always seen from the outside.

- Left  
 Right

**Attention!** If the wire of the electrical control (outside) goes in on the left side, the wire is, seen from the inside, on the right side and vice versa.

## Extra attention points!

### Watch for any obstacles!

Take rain pipes and other obstacles that can obstruct mounting on the wall into account.

### Check the installation height

Check if you have enough installation height on the façade to install the awning. Above the wall supports (installation support) need to be five rows of stones to prevent the amount of pressure on the façade. Especially with an extension, this can not be the case. It is advisable to drill the top installation hole in the middle of the fifth stone from the top.

**Attention!** Make sure that there is not an installation point in the soldier course. Mostly, these are often half stones.

### Patio doors and windows

If the awning is open, the awning hangs in a downward angle. Keep at least 30 centimeters between the window frame and the underside of the awning. It is advisable to install the awning higher than 30 cm above the window frame.

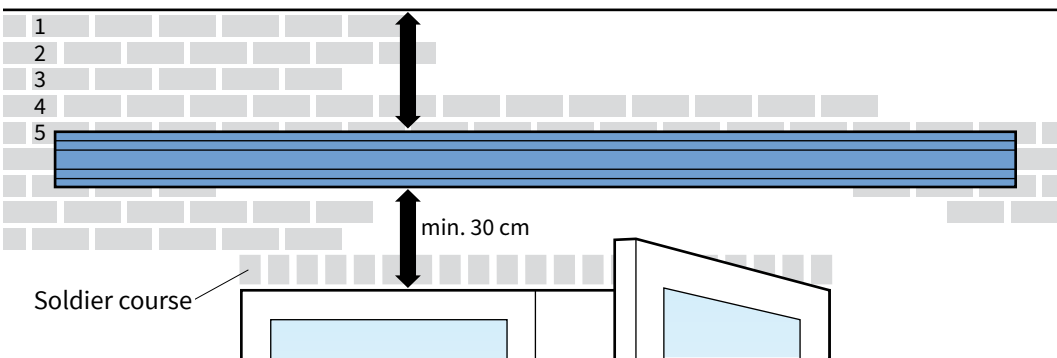

### Height front bar

Make sure that you have enough space for the installation hole on the façade, so that the front bar has enough height and you can enjoy the projection optimally. For a good passage, a minimal installation height of 2,40 meter is necessary. You can set the pitch of the awning yourself. Please see the specifications on page 3.

### Wall strips

If there are less than five rows of stones above the wall support, wall strips need to be used. These strips divide the forces over a bigger wall surface if walls are too weak.

**Attention!** In case of an extension, never install the wall strips too close to the drainage.

**Remark!** If you use a center support, you need to order an extra wall strip.

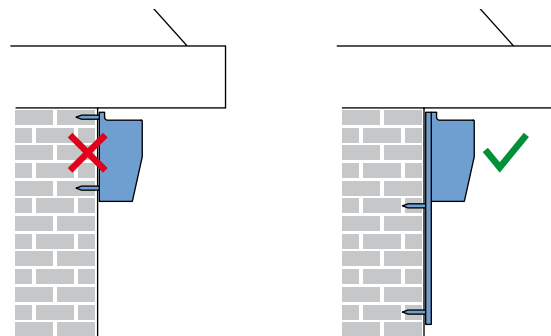

## General warning

Measuring the Verano® product yourself is at your own risk. You are responsible for measuring the right sizes. Use this instruction only as a tool and only for measuring this specific Verano® product. When you are not sure about the measuring and you don't want the risk of ordering a wrong product, use the measuring service of your Verano® dealer.

## Specifications

### Wall installation

Sizes in mm

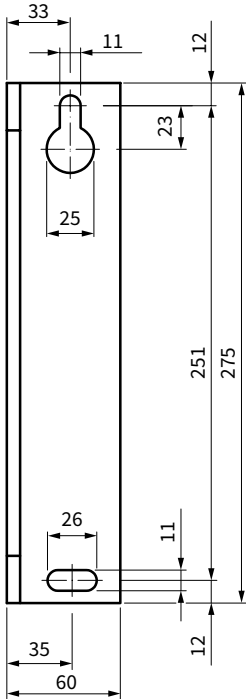

Front view left wall support

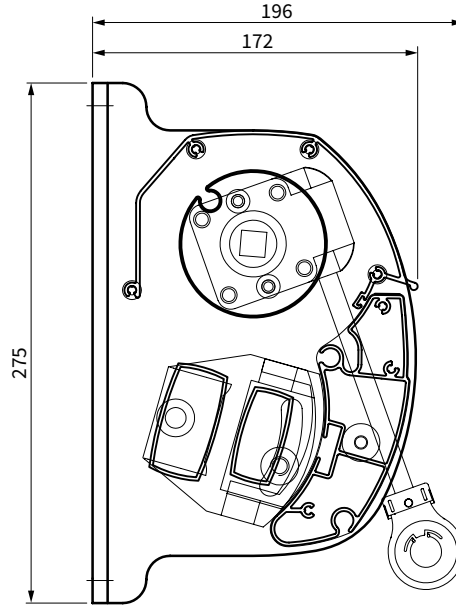

Section awning

### Minimal width (W) per fabric projection

Projection [mm]	Minimal awning width (W) [mm]
1500	1655
2000	2235
2500	2740
3000	3320

### Width (W)

<b>Minimal 1655 mm</b>	<b>Maximal 6000 mm</b>
------------------------	------------------------

### Projection

