

V550 - RITZSCREEN®

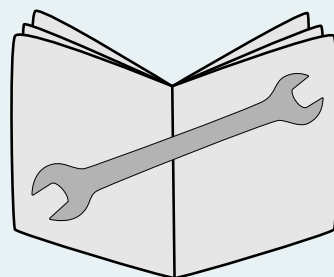

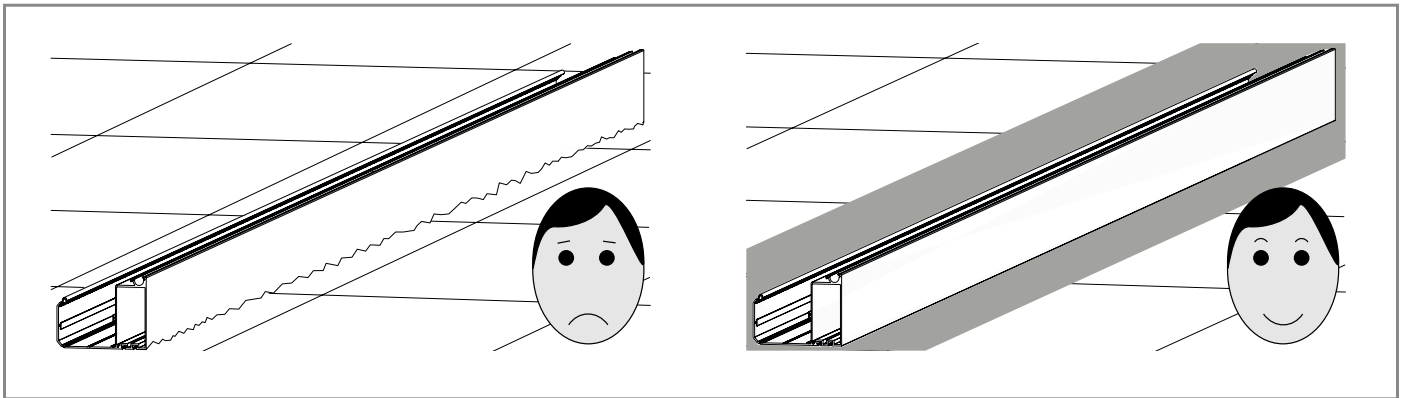

Zuurvrij
Acid-free
Säurefrei
Sans acide
Sin ácido

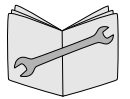

Fout
Wrong
Falsch
Pas bien
No es bueno



Goed
Right
Recht
Bien
Bueno

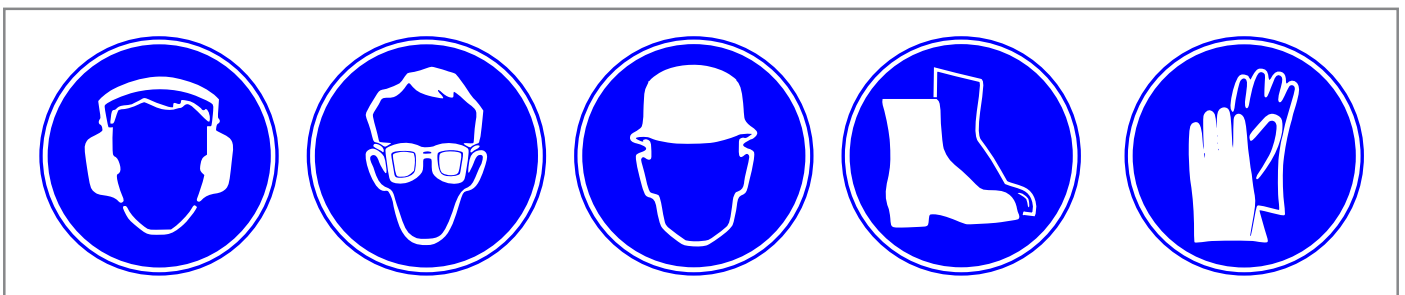

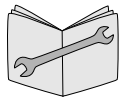
**Algemene waarschuwing**

Als u het Verano® product zelf monteert, is dat voor uw eigen risico. Gebruik deze instructie slechts als een hulpmiddel en alleen bij montage van dit specifieke Verano® product. Mocht u er zelf niet uitkomen, dan kunt u altijd kiezen voor professionele montage. Het montageteam van uw Verano® partner staat graag voor u klaar.

Pas op voor beschadigingen

Gebruik geen mes of ander scherp voorwerp bij het openen van de verpakking. De inhoud zou beschadigd kunnen raken. Leg de inhoud op een zachte ondergrond.

Pas op wanneer u gaat boren. Vallend boorgruis kan beschadigingen veroorzaken.

Controleer of de gevel vlak is.

Drukfouten, fouten en technische wijzigingen voorbehouden.

General warning

Mounting the Verano® product yourself is at your own risk. Only use this instruction as a tool and for the mounting of this specific Verano® product. If you cannot mount the product yourself, you can always opt for professional mounting. The mounting team of Verano® is pleased to help you.

Be careful for damages

Don't use a knife or any other sharp object when opening the packing. This may cause damage to the content of the package. Put the content of the package on a soft surface.

Be careful when drilling, falling drill cuttings can cause damages.

Check if the façade is flat and smooth.

Printing errors, errors and technical changes reserved.

Warnhinweise

Wenn Sie das Verano®-Produkt selbst montieren, ist das Ihr eigenes Risiko. Verwenden Sie diese Anleitung nur als ein Hilfsmittel und nur bei der Montage dieses spezifischen Verano® Produkts. Wenn es Ihnen nicht selbst gelingt, dann können Sie sich immer für professionelle Montage entscheiden. Das Montageteam Ihres Verano®-Händlers steht Ihnen gerne bereit.

Vorsicht vor Beschädigungen

Verwenden Sie beim Öffnen der Verpackung kein Messer oder einen anderen scharfen Gegenstand. Der Inhalt könnte beschädigt werden. Legen Sie den Inhalt auf eine weiche Unterlage.

Vorsicht beim Bohren. Fallender Bohrstaub kann Beschädigungen verursachen.

Überprüfen Sie, ob die Fassade eben ist.

Druckfehler, Fehler und technische Änderungen vorbehalten.

Avertissement général

Vous montez le produit Verano® vous-même à vos propres risques. Les présentes instructions ne constituent qu'une aide au montage du produit Verano® concerné. Si vous ne parvenez pas à monter ce produit vous-même, faites appel à un professionnel. L'équipe de montage de votre revendeur Verano® est à votre disposition.

Prenez garde à ne pas endommager le produit

N'utilisez pas de couteau ni d'autre objet tranchant pour ouvrir le paquet, afin de ne pas endommager le contenu. Disposez le contenu sur une surface douce.

Soyez prudent lorsque vous percez des trous. La chute des débris de forage peut provoquer des dégâts.

Assurez-vous que la façade sont plans.

Erreurs d'impression, erreurs et modifications techniques réservées.

Advertencia general

Instalar el producto de verano por tu cuenta corre bajo tu propio riesgo. Usa este manual como una herramienta de ayuda y únicamente para la instalación de este producto específico de Verano. Si no puedes instalar este producto por ti mismo, siempre puedes optar por la instalación profesional. El equipo de instaladores de tu distribuidor Verano estará encantado de ayudarte.

Cuidado con los posibles daños en el producto

No uses un cuchillo o cualquier otro objeto afilado a la hora de abrir el embalaje. Esto puede causar daños en el contenido del paquete. Coloca el contenido en una superficie suave.

Cuidado con los restos que caigan a la hora de taladrar, esto también puede causar daños en el producto.

Comprueba que la fachada esté completamente plano.

Sujetos a erratas, errores y modificaciones técnicas.

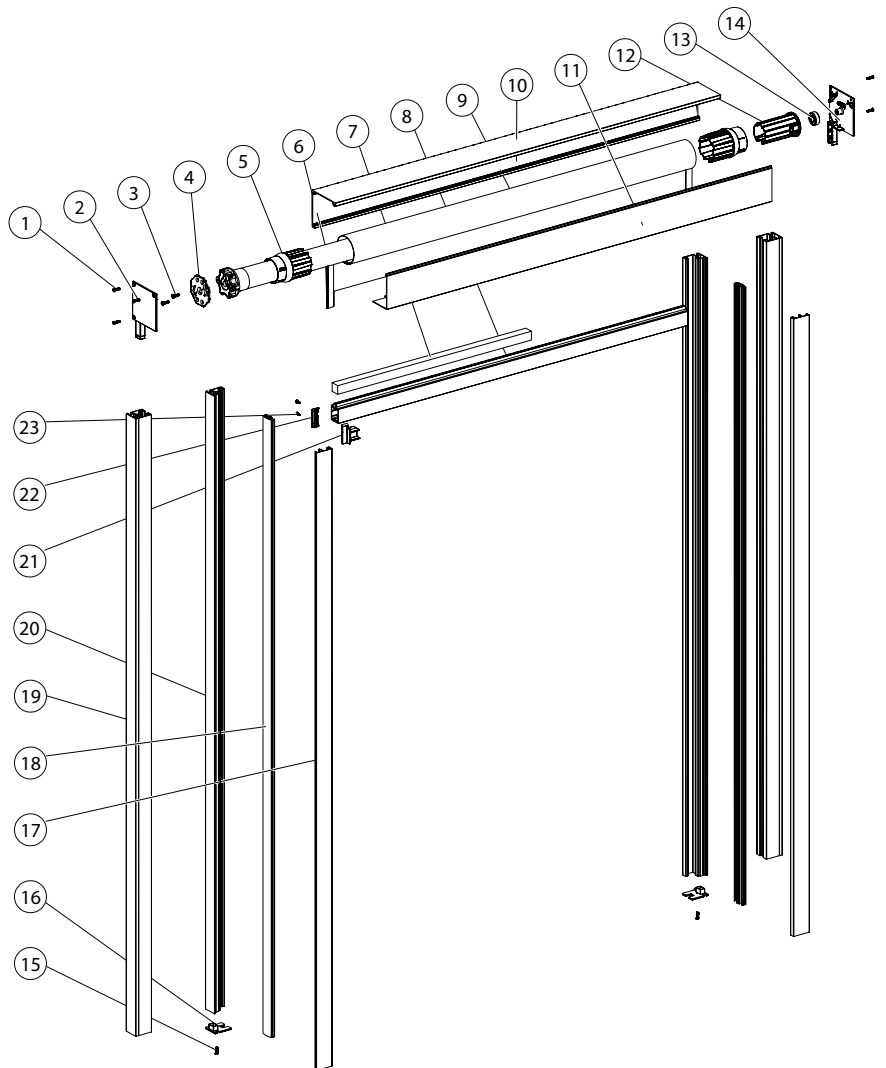
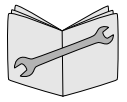

Verano artikel nr.	Description	BOM ID
7982-2-35016	DIN 7982 3,5	1
SC.550.80.04.XX	1662-022	2
EB.10.00.00.00	EB.10.00.00.00	3
SC.550.80.00.00	1662-014	4
SC.550.30.63.00	1705-007	5
EB.10.51.110.01	Somfy serie 50	6
SL.550.60.60.00	1662-019	7
	1662-100	8
	1662-103	9
	1662-101	10
	1662-102	11
SC.550.30.00.00	1705-008	12

Verano artikel nr.	Description	BOM ID
RC.726.28.66	kogellager 6001-z	13
SC.550.80.01.xx	1662-026	14
7982-2-35016	DIN 7982 3,5	15
SC.540.20.00.00	1662-005	16
	1662-106[1]	17
	1662-004[1]	18
	1662-104-01	19
	1662-105[1]	20
SC.540.20.00.00	1662-006	21
SC.540.20.00.00	1662-007	22
7982-2-35095	DIN 7982 3,5	23

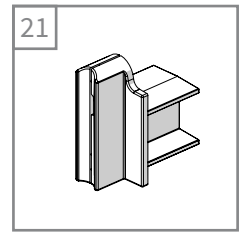
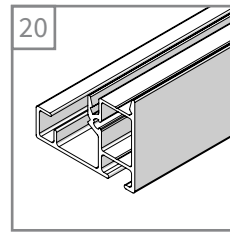
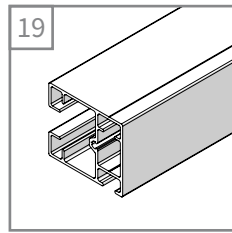
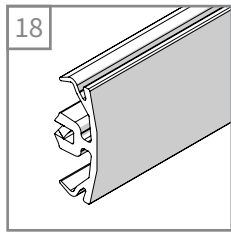
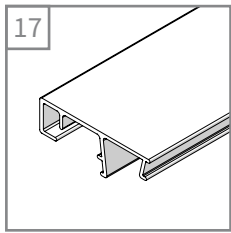
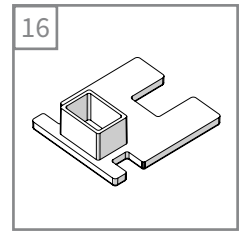
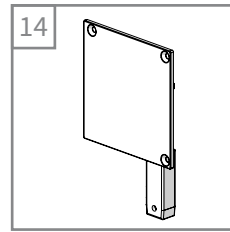
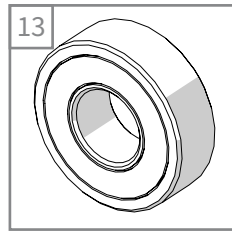
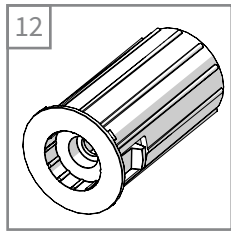
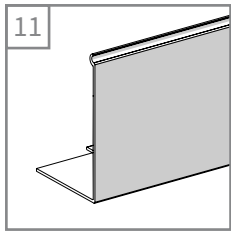
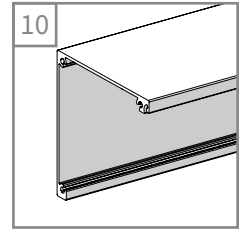
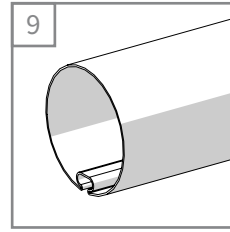
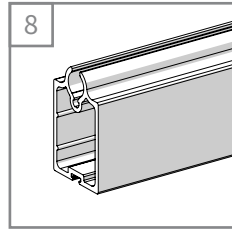
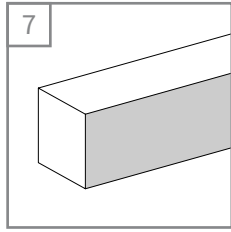
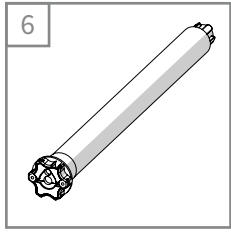
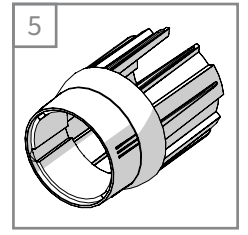
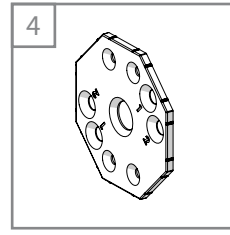
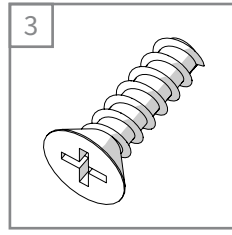
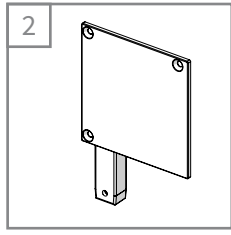
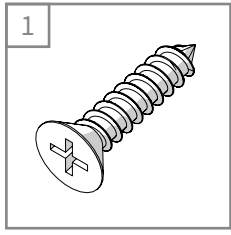
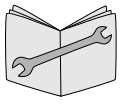

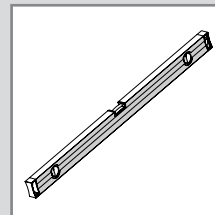
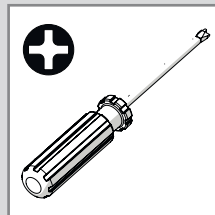
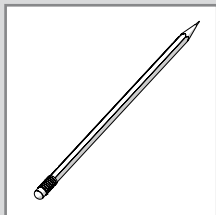
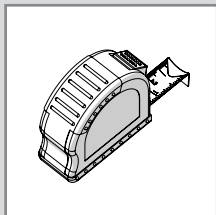
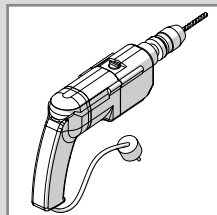
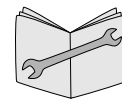

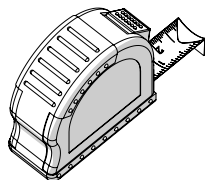
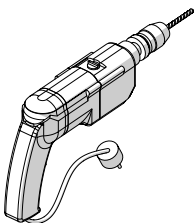
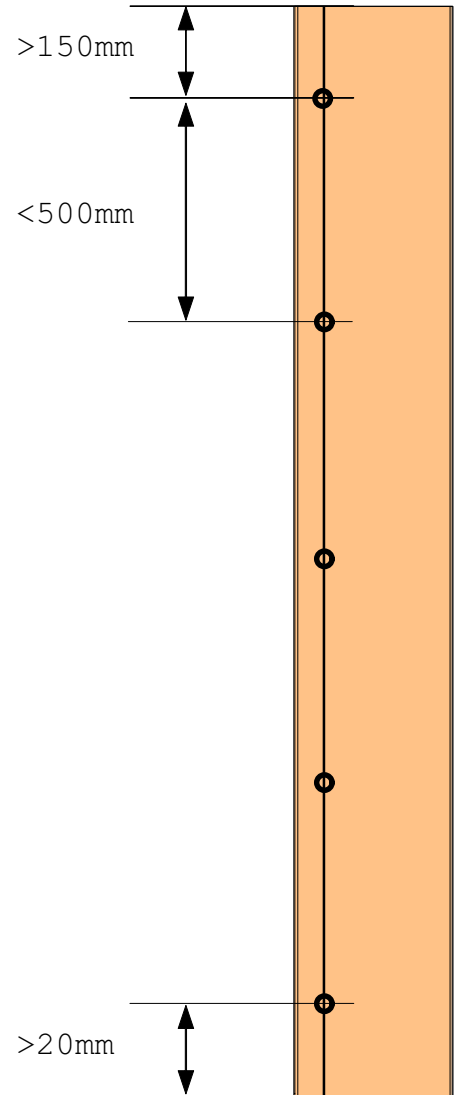
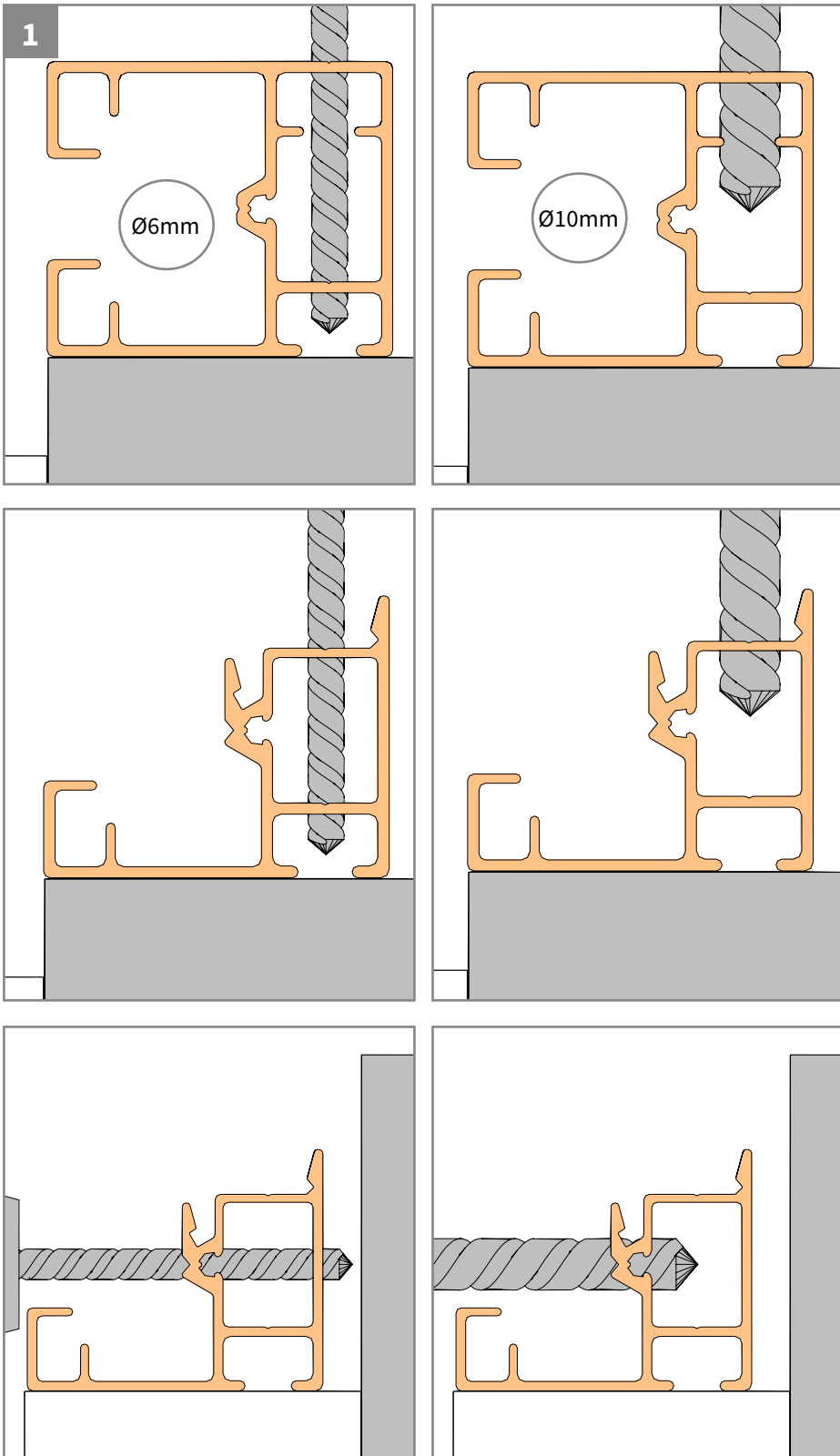
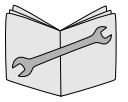

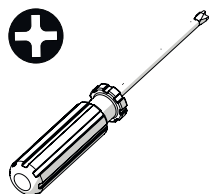
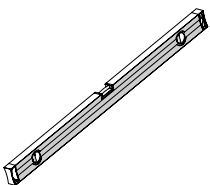
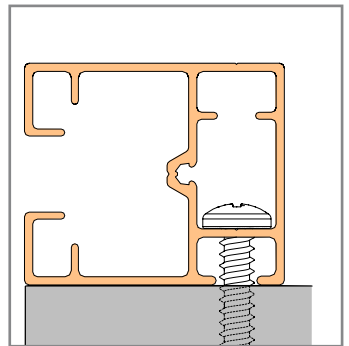
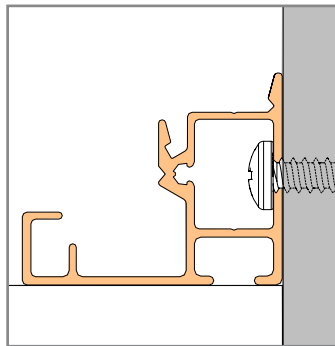
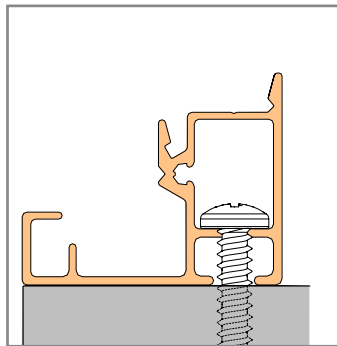
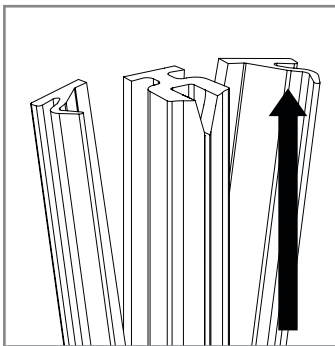
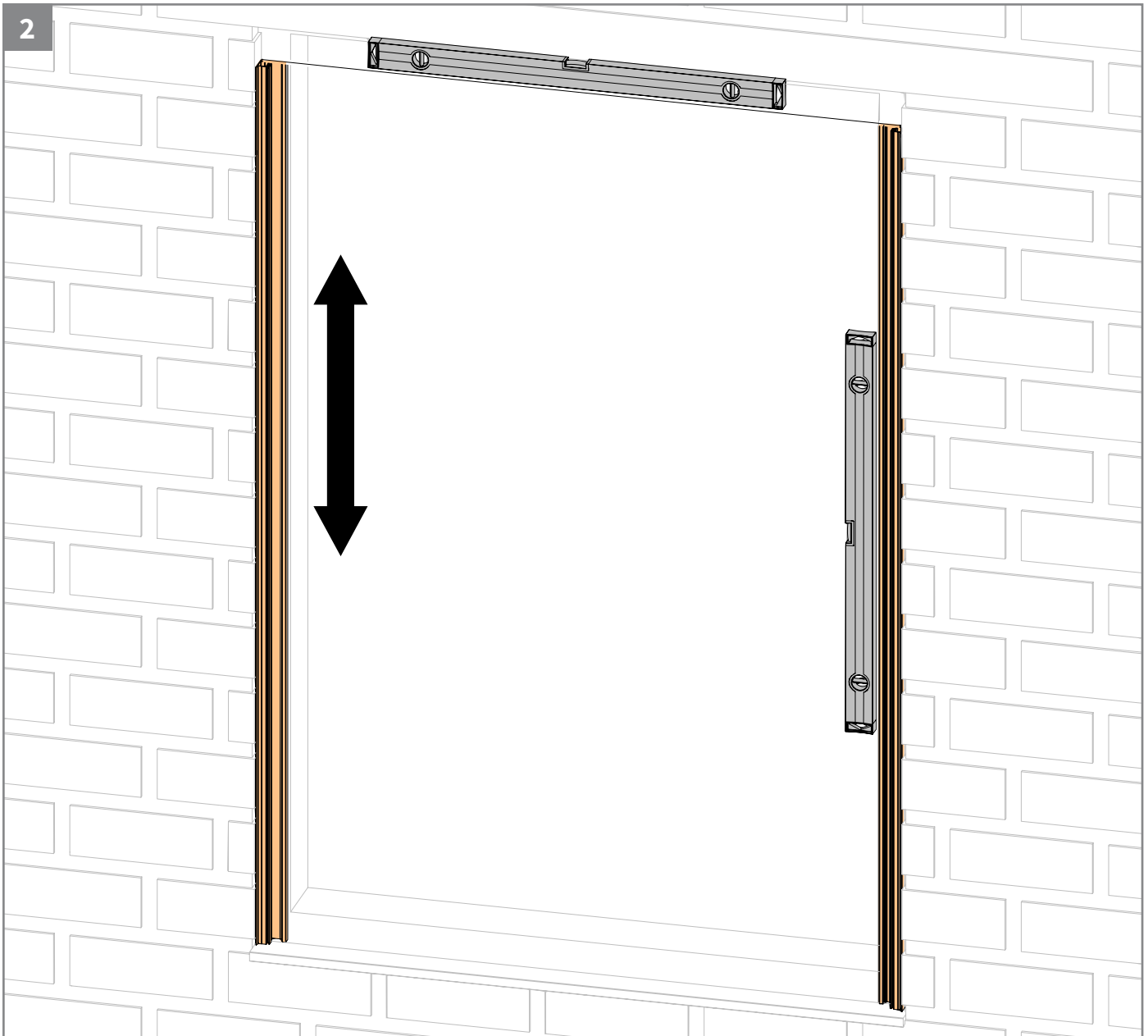
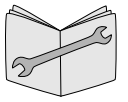

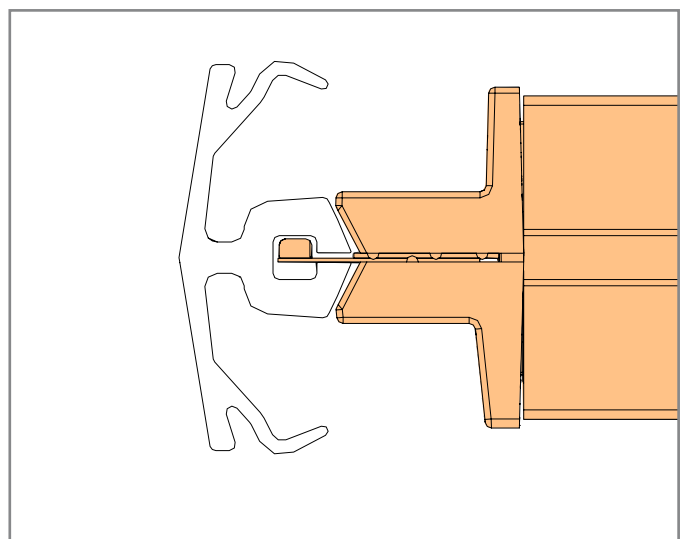
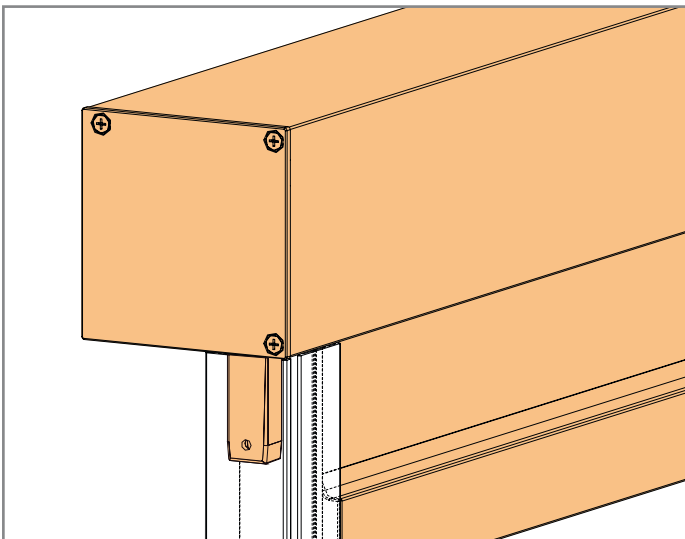
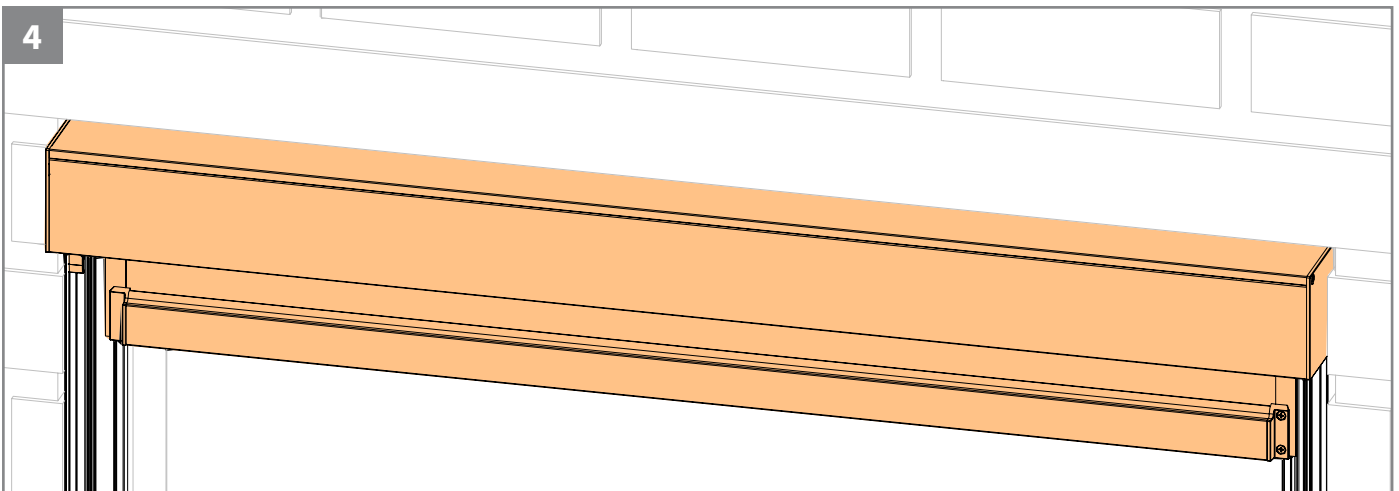
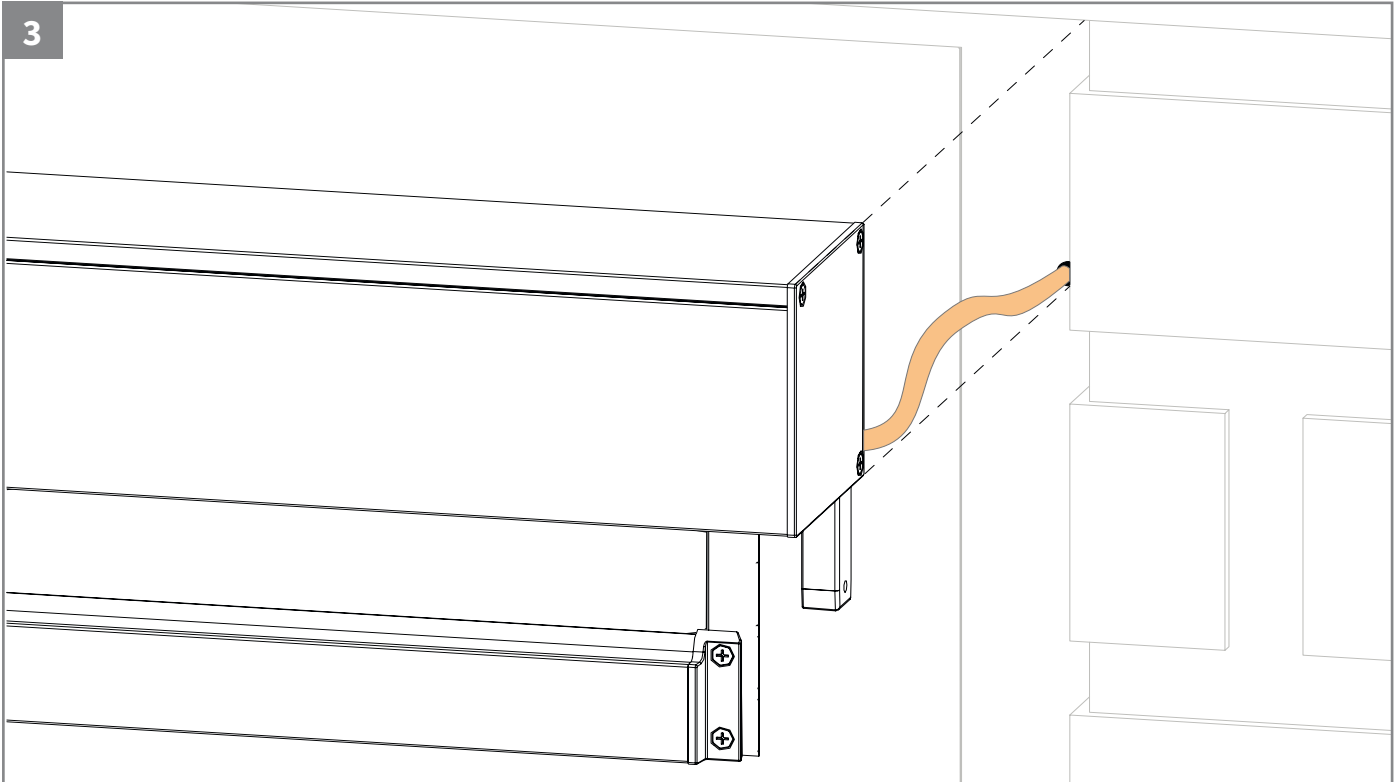
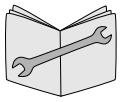

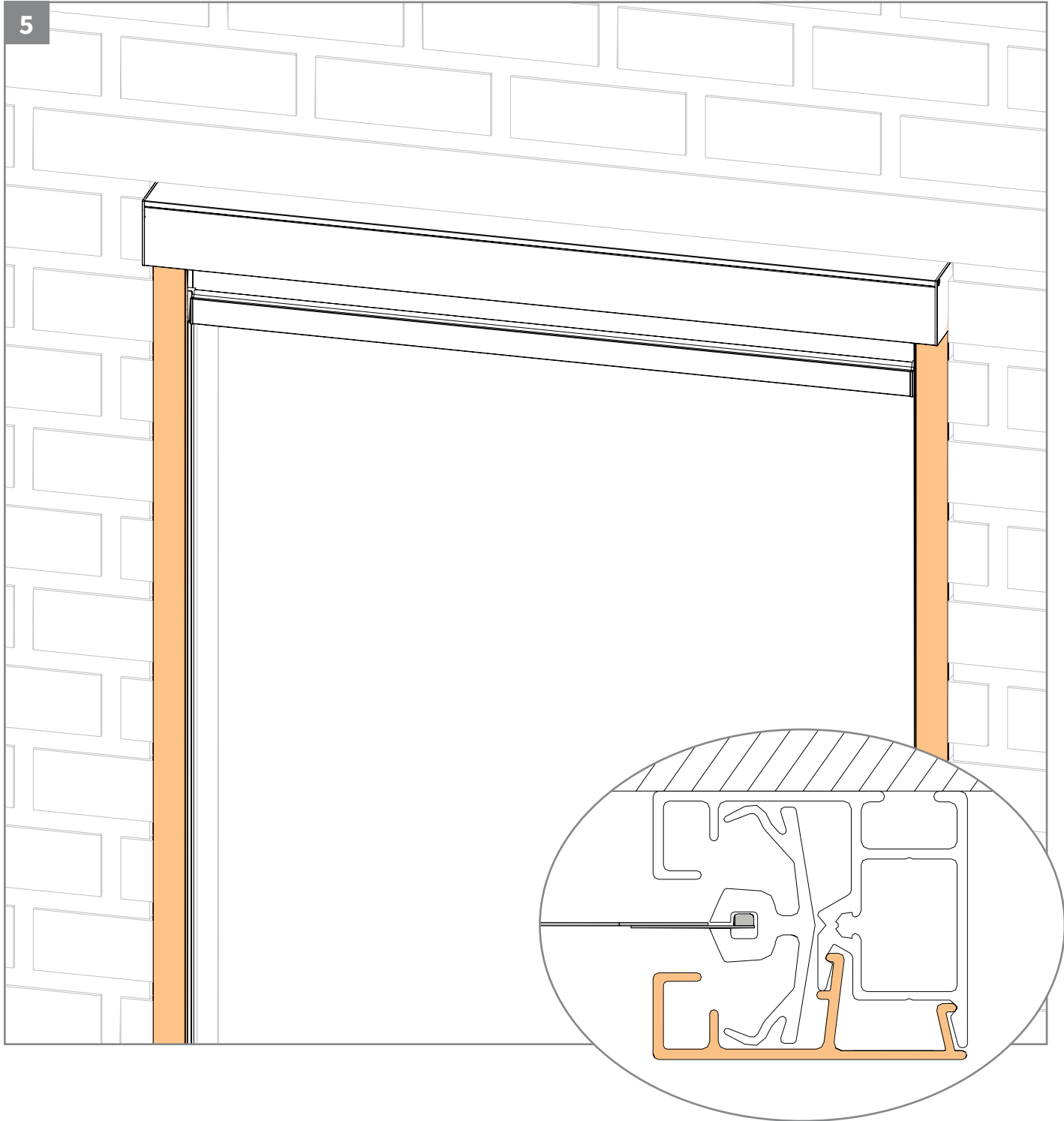
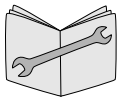

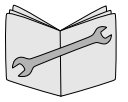

6

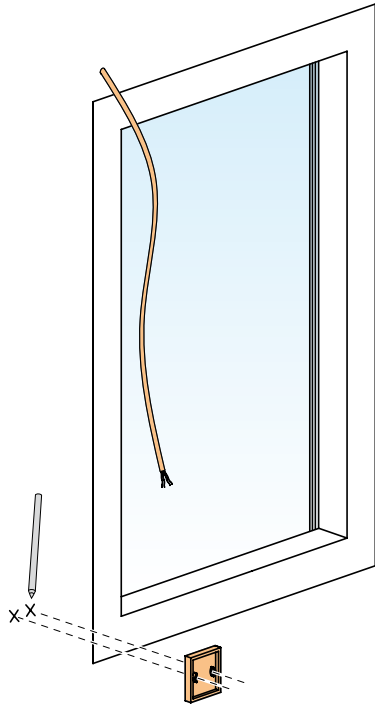

230 V

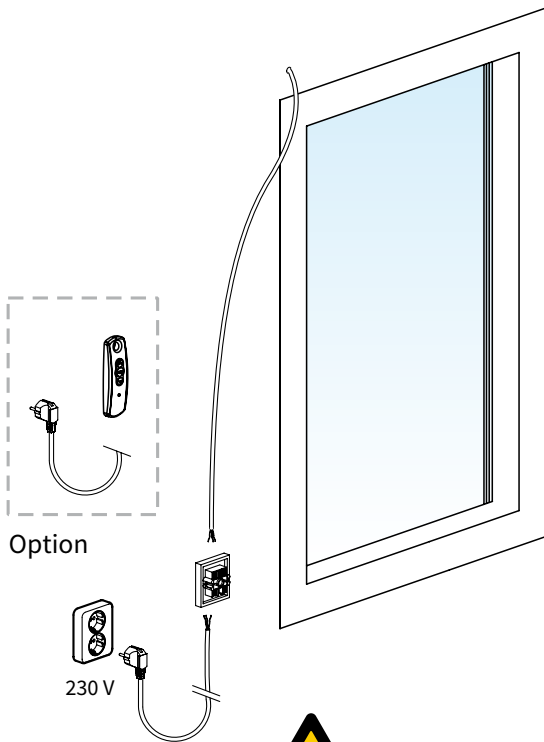
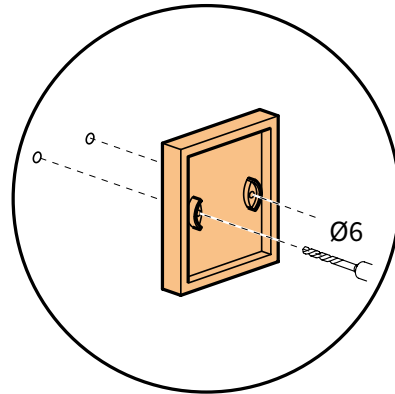
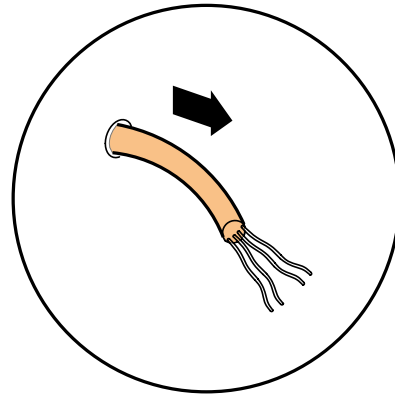

Option

230 V

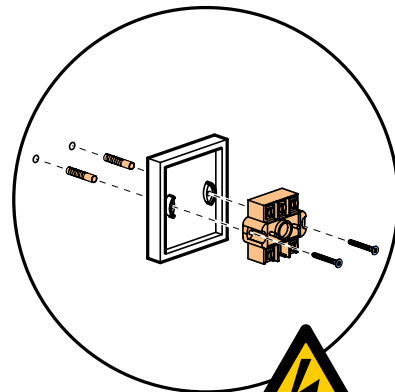
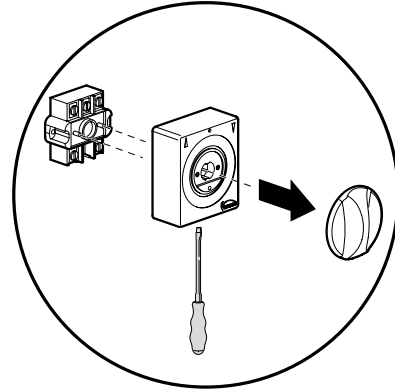

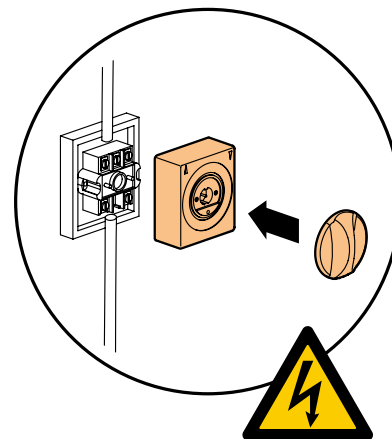
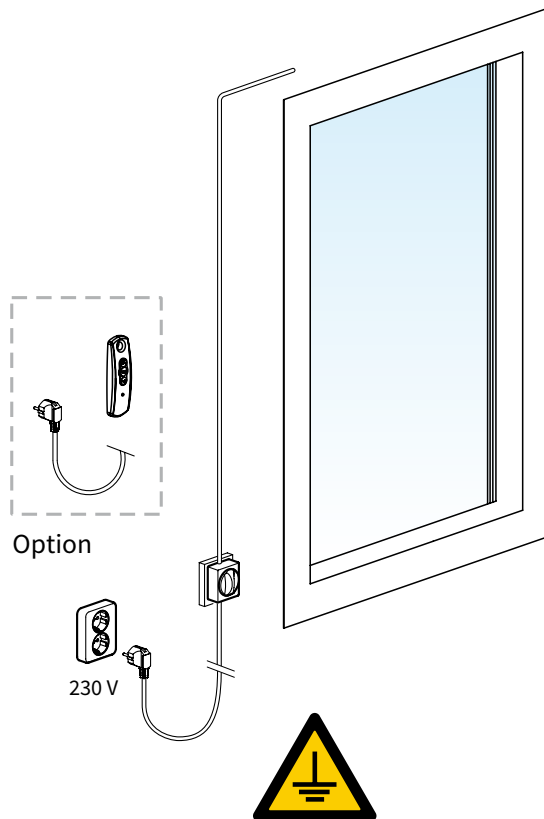
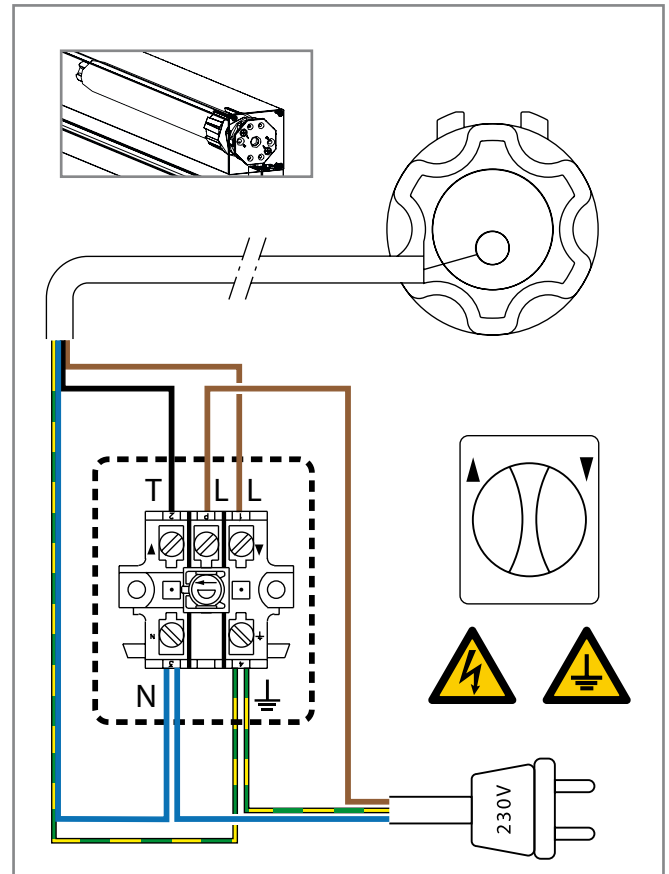
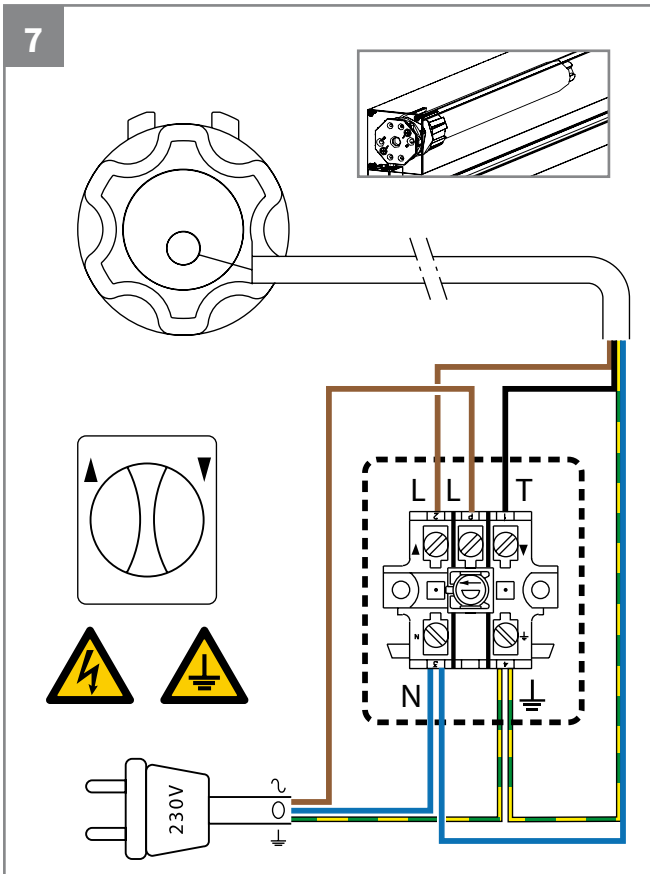
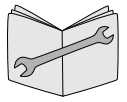

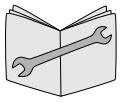

Option

